

18+

MONTHS / MONATE

PLAYHOUSE USED
WITHOUT A DECK
SPIELHAUS OHNE
DECK VERWENDBAR

3+

YEARS / JAHRE

PLAYHOUSE USED
WITH A DECK
SPIELHAUS AUF EINEM
DECK VERWENDET



PLAYHOUSE USED
WITH A DECK
SPIELHAUS AUF EINEM
DECK VERWENDET

ASSEMBLY / MONTAGE



x2 Person build



1.5hr Build time

! 50kg

MAXIMUM COMBINED
USER WEIGHT
MAXIMALES
KOMBINIERTES
BENUTZERGEWICHT

PLAYHOUSE USED
WITHOUT A DECK
SPIELHAUS OHNE
DECK VERWENDBAR

! 100kg

MAXIMUM COMBINED
USER WEIGHT
MAXIMALES
KOMBINIERTES
BENUTZERGEWICHT

PLAYHOUSE USED
WITH A DECK
SPIELHAUS AUF EINEM DECK
VERWENDET

Instructions for assembly, maintenance and safe use.

Anweisungen für Montage, Wartung und sicheren Gebrauch.



WARNINGS!

EN

- **PLAYHOUSE USED WITHOUT A DECK** - THIS PRODUCT IS INTENDED FOR USE BY CHILDREN FROM AGES 18+ MONTHS - MAXIMUM USER WEIGHT PER USER 30KGS - MAXIMUM COMBINED USER WEIGHT FOR THIS PRODUCT 50 KGS
- **PLAYHOUSE USED ON A DECK** - THIS PRODUCT IS INTENDED FOR USE BY CHILDREN FROM AGES 3+ YEARS - MAXIMUM USER WEIGHT PER USER 30KGS - MAXIMUM COMBINED USER WEIGHT FOR THIS PRODUCT 100 KGS
- THIS PRODUCT CONTAINS COMPONENTS THAT HAVE SMALL PARTS AND SHARP POINTS. IT IS NOT SUITABLE FOR CHILDREN UNDER 36 MONTHS UNTIL FULLY ASSEMBLED.
- ONLY FOR DOMESTIC USE. FOR OUTDOOR USE ONLY.
- TOY MUST BE ASSEMBLED BY AN ADULT BEFORE USE.
- CHILDREN MUST NOT USE THIS PRODUCT UNTIL PROPERLY INSTALLED.
- ADULT SUPERVISION REQUIRED.
- KEEP AWAY FROM FIRE.
- REMOVE ALL PACKAGING BEFORE GIVING TO YOUR CHILDREN.
- RETAIN PACKAGING FOR FUTURE REFERENCE.
- PLEASE RETAIN INSTRUCTIONS AS IT CONTAINS IMPORTANT SAFETY INFORMATION.

Instructions for assembly, maintenance and safe use.

Please retain this information for future reference.

1. Toy must be assembled by an adult before use exactly in accordance with the instructions.
2. Children must not use this product until properly installed.
3. Check all parts are present before you start to assemble the product. Place small parts on a tray or similar to ensure they are not lost. The manufacturing process can very occasionally result in sharp edges/waste material so please take care when assembling this product.
4. If any parts are missing do not use the product until the replacement parts are fitted.
5. Ensure your product is sited on level ground. Failure to do this may put additional stress on connections and joints and in time could cause them to fail.
6. Ensure your product is located on a soft impact surface like grass. Never locate your product on hard surfaces like concrete.
7. Avoid locating this product in full sun.
8. Remove all packaging before giving to your children.
9. Equipment should be checked by an adult at the beginning of each season and at regular intervals during the usage season to ensure it is safe. Pay special attention to all connections and fastenings.
10. Parts may need to be replaced if they show signs of wear and tear. Replace any defective parts in accordance with these instructions.
11. Due to the natural characteristics of timber, it is vital to check your playframe regularly for splintering, lifting of surface layers of wood or exposure of rough wood. Affected areas must be rubbed down using coarse sandpaper to restore a smooth, safe surface.
12. Any changes to this toy eg changing or adding an accessory, must be done in accordance with our instructions. Failure to do this will render your guarantee null and void and may make your product unsafe.
13. Ensure children's clothing is appropriate for the play activity.
14. Never place toys near a fire.
15. In high winds, ensure outdoor toys are moved to a sheltered position and/or securely staked down.
16. The age recommendation for this product is clearly stated on the packaging and in these instructions. Please adhere to it at all times. Adult supervision is required at all times to ensure children play safely.
17. When you dispose of this equipment please do so responsibly.



WARNUNG!

DE

- **SPIELHAUS OHNE DECK VERWENDBAR** - DIESES PRODUKT IST FÜR KINDER AB EINEM ALTER VON 18+ MONATEN BESTIMMT - MAXIMALES BENUTZERGEWICHT PRO BENUTZER: 30 KG - MAXIMALES KOMBINIERTES BENUTZERGEWICHT 50 KG
- **SPIELHAUS AUF EINEM DECK VERWENDET** - DIESES PRODUKT EIGNET SICH FÜR KINDER ZWISCHEN 3 + JAHRE - MAXIMALES BENUTZERGEWICHT PRO BENUTZER: 30 KG - MAXIMALES KOMBINIERTES BENUTZERGEWICHT 100 KG
- DIESES PRODUKT ENTHÄLT KOMponentEN MIT KLEINEN TEILEN UND SCHARFEN SPITZEN. IST FÜR KINDER UNTER 36 MONATEN BIS ZUR VOLLSTÄNDIGEN MONTAGE NICHT GEEIGNET.
- NUR FÜR DEN HÄUSLICHEN GEBRAUCH. FÜR DRAUSSEN.
- DAS SPIELZEUG MUSS VOR GEBRAUCH VON EINEM ERWACHSENEN GENAU NACH ANLEITUNG ZUSAMMENGEBAUT WERDEN.
- KINDER DÜRFEN DAS PRODUKT NICHT BENUTZEN, BEVOR ES NICHT KORREKT AUFGEBAUT WURDE.
- AUFSICHT DURCH EINEN ERWACHSENEN ERFORDERLICH.
- VON FEUER FERNHALTEN.
- ALLE VERPACKUNGEN ENTFERNEN, BEVOR IHRE KINDER DAS PRODUKT ERHALTEN ODER DAMIT SPIELEN DÜRFEN.
- BITTE DIE VERPACKUNG FÜR ZUKÜNFTIGE VERWENDUNG AUFHEBEN. BITTE DIE ANLEITUNG AUFBEWAHREN – SIE ENTHÄLT WICHTIGE SICHERHEITSHINWEISE

Zusammenbau-, Wartungs- und Gebrauchsanweisungen.

Bitte diese Informationen zur späteren Bezugnahme aufbewahren.

1. Das Spielzeug muss vor Gebrauch von einem Erwachsenen genau nach Anleitung zusammengebaut werden.
2. Kinder dürfen das Produkt nicht benutzen, bevor es nicht korrekt aufgebaut wurde
3. Vor Zusammenbau des Produkts überprüfen, dass alle Teile vorhanden sind. Kleine Teile auf ein Tablett oder Ähnliches legen, damit sie nicht verloren gehen. Der Herstellungsprozess kann gelegentlich zu scharfen Kanten/Materialresten führen; seien Sie daher vorsichtig beim Zusammenbau dieses Produkts.
4. Sollten irgendwelche Teile fehlen, das Produkt nicht verwenden, bis die Ersatzteile angebracht wurden.
5. Sicherstellen, dass das Produkt auf ebenem Untergrund steht. Bei Nichtbeachtung können die Verbindungsteile und Gelenke zusätzlicher Belastung ausgesetzt werden und versagen.
6. Sicherstellen, dass Ihr Produkt auf weichem Boden wie Gras steht. Das Produkt niemals auf hartem Boden wie Beton aufstellen.
7. Diese Produkt nicht in der vollen Sonne aufstellen.
8. Alle Verpackungen entfernen, bevor Ihre Kinder das Produkt erhalten oder damit spielen dürfen.
9. Geräte sollte zu Beginn jeder Saison sowie regelmäßig während der Gebrauchssaison von einem Erwachsenen überprüft werden, um ihre Sicherheit zu gewährleisten. Besonders auf alle Verbindungen und Befestigungen achten.
10. Teile müssen bei Abnutzungserscheinungen u. U. ersetzt werden. Alle fehlerhaften Teile gemäß diesen Anleitungen ersetzen.
11. Aufgrund der natürlichen Eigenschaften von Holz ist es sehr wichtig, Ihren Spielrahmen regelmäßig auf Splitter sowie abgehobene Oberflächen und raues Holz zu überprüfen. Betroffene Bereiche mit grobem Schleifpapier abschmiegeln, um wieder eine glatte, sichere Oberfläche zu schaffen.
12. Bei allen Abänderungen des Spielzeugs, z. B. Auswechseln oder Hinzufügen von Zubehör, unsere Anleitungen befolgen. Nichtbeachtung führt zum Erlöschen Ihrer Garantie und kann bedeuten, dass Ihr Produkt nicht länger sicher ist.
13. Für die Spielaktivität geeignete Kinderkleidung wählen.
14. Niemals Spielzeug in der Nähe von Feuer aufstellen.
15. Bei starkem Wind sicherstellen, dass Spielzeug für draußen an eine geschützte Position verlegt wird und/oder fest verankert ist.
16. Das empfohlene Alter für dieses Produkt ist deutlich auf der Verpackung und in diesen Anleitungen angegeben. Bitte sich stets daran halten. Aufsicht durch Erwachsene ist sehr erforderlich, um die Sicherheit von Kindern beim Spielen zu gewährleisten.
17. Bitte dieses Gerät verantwortungsvoll entsorgen.

Safe Play Area Sicherer Spielbereich

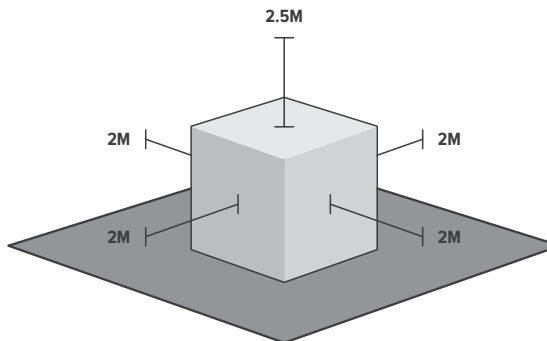

The safe play area refers to the zone extending 200cm around the toys on all sides and 250 cm above the toy. The safe play area must be free from all obstacles.



Der sichere Spielbereich bezieht sich auf eine Zone von 200 cm rund um das Spielzeug sowie 250 cm oberhalb des Spielzeugs. Der sichere Spielbereich muss frei von allen Hindernissen sein.

Dimensions • Maße

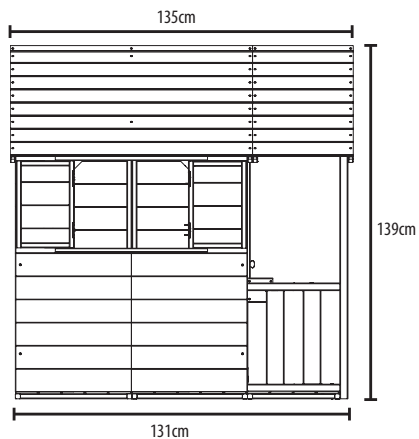
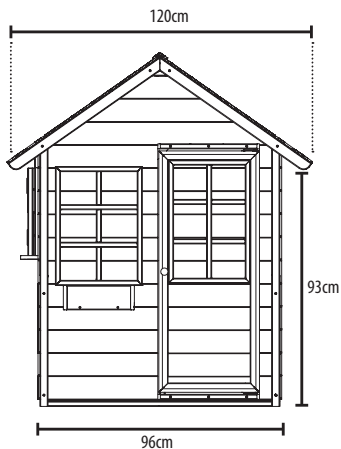

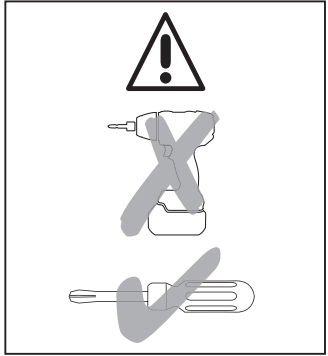
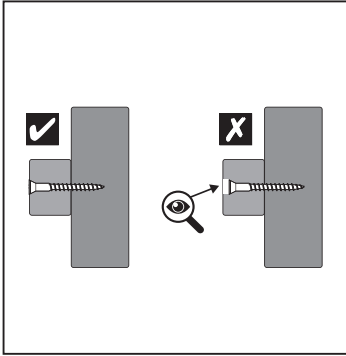
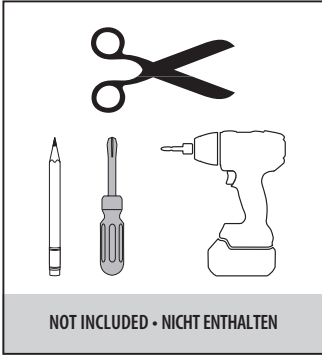

Contents • Inhalt



MW9275-7016 **x4**



MW9289-7016 **x4**



MW9309-WHT **x1**



MW2217-WHT **x1**



MW9340-WHT **x1**



MW9312 **x2**



MW9304 **x1**



MW9308 **x1**



MW9290-WHT **x2**

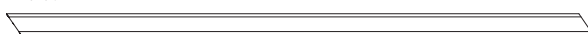

MW9315-7016 **x2**



MW9319-7016 **x16**



MW9314-7016 **x12**

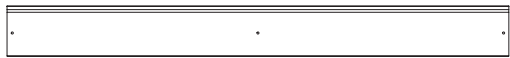

MW9316-7016 **x4**

SP5417

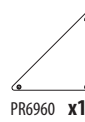
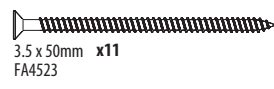
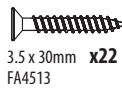
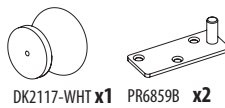
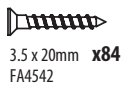
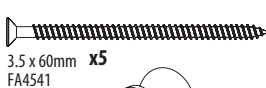

PM1970 **x1**

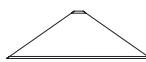

MW2113-7016 **x1**



MW9291-WHT **x2**



MW2116-WHT **x2**

Contents • Inhalt

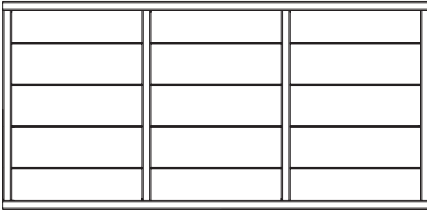

WP3000 x1

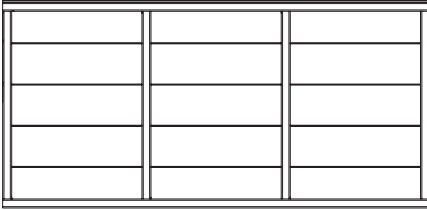

WP3001 x1

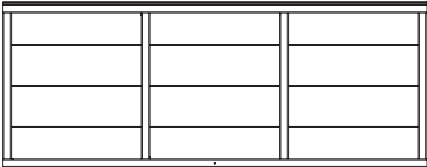

WP3002 x1



MW9346-7016 x2



MW3395-7016 x2



MW9348-7016 x1

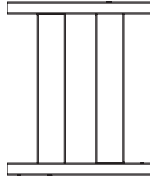

WP3019-WHT x2

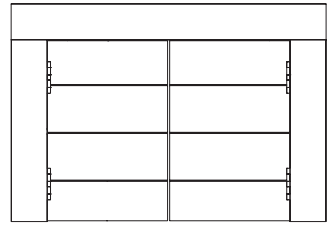

WP2052SA-7016 x1

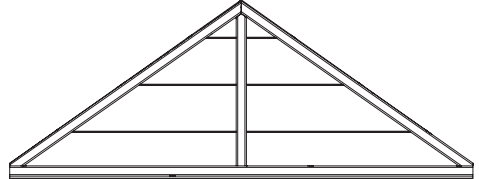

WP3011 x2

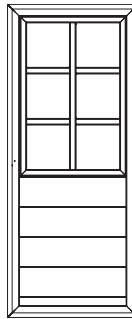

WP1005-7016 x1

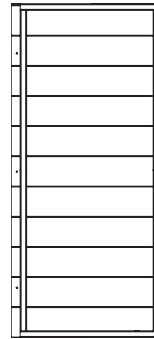

WP3005 x1

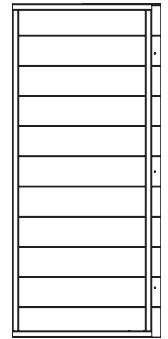

WP3006 x1

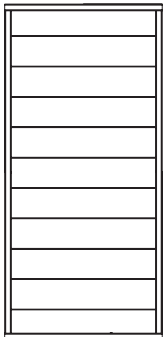

WP3003 x1

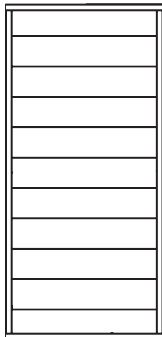

WP3004 x1

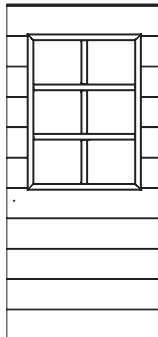

WP3010-WHT x1



WP3009 x1

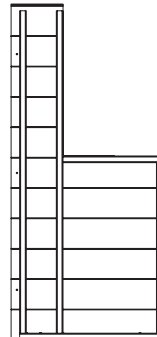

WP3007 x1

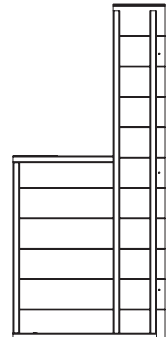

WP3008 x1

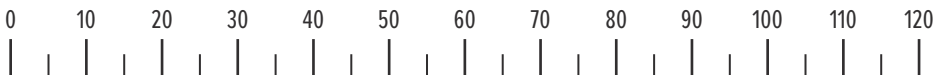

MM

1

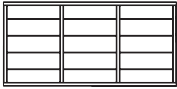

WP3000 **x1**



WP3001 **x1**

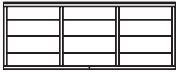

WP3002 **x1**



FA4525 - 3.5 x 35mm **x6**

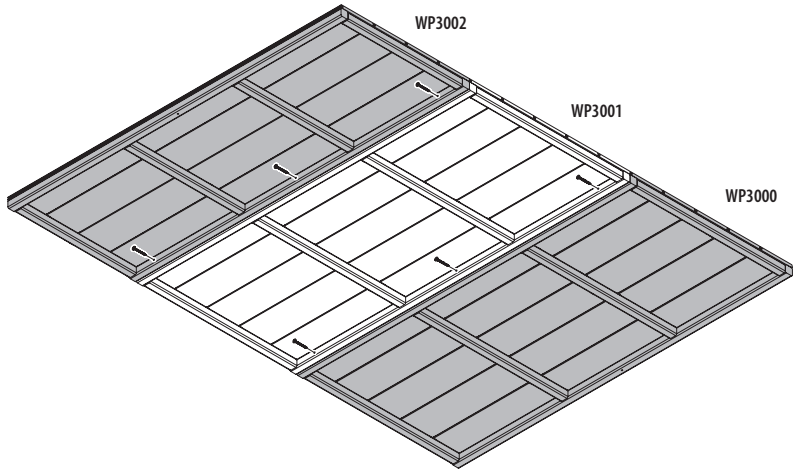

2



FA4522 - 3.5 x 40mm **x8**

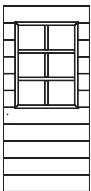

WP3010-WHT **x1**



WP3009 **x1**



MW9304 **x1**



MW9308 **x1**

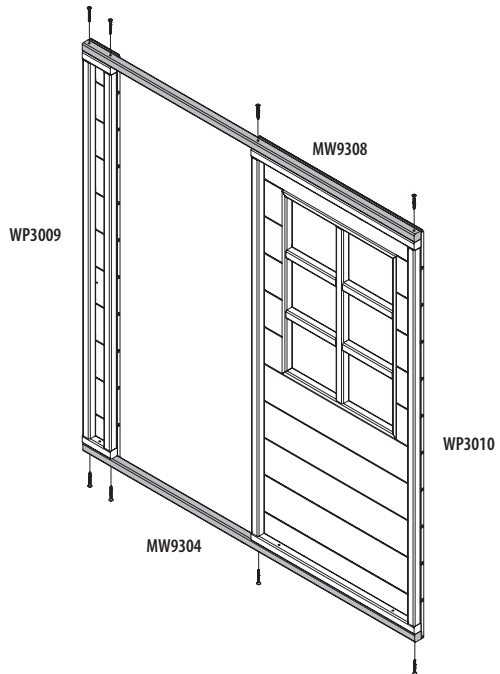

3

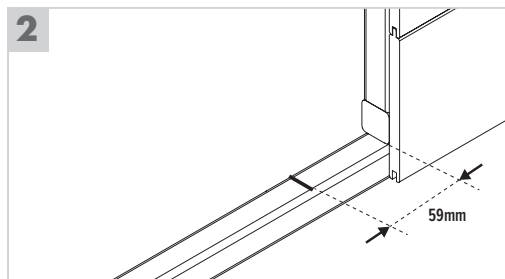
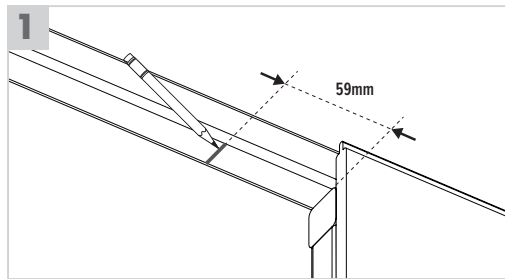
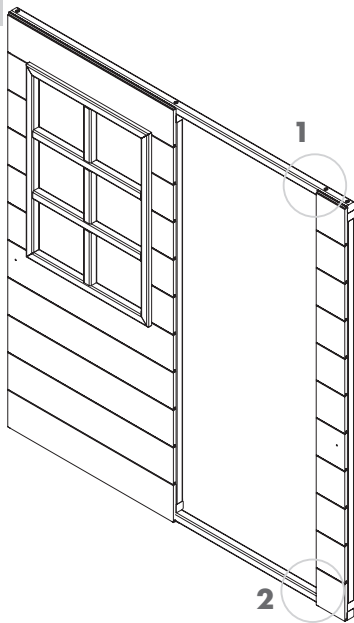

4

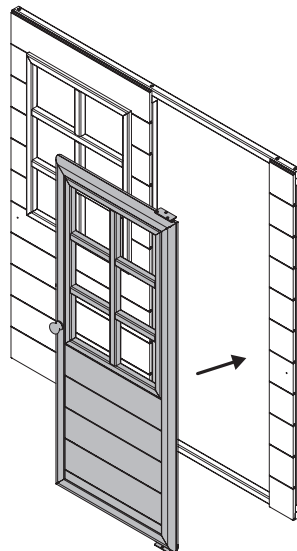
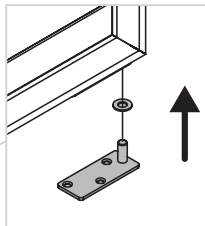
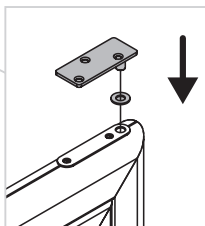
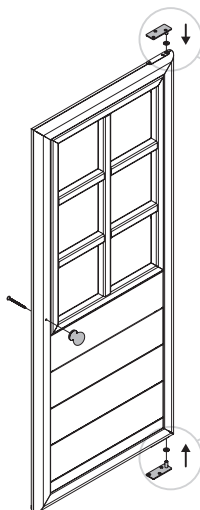
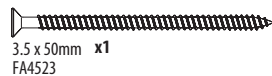
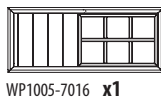
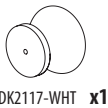
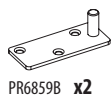

5

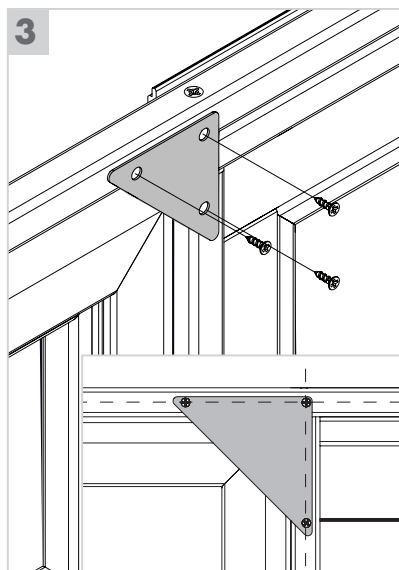
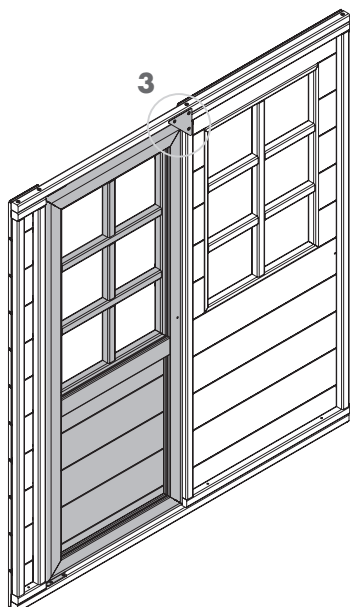
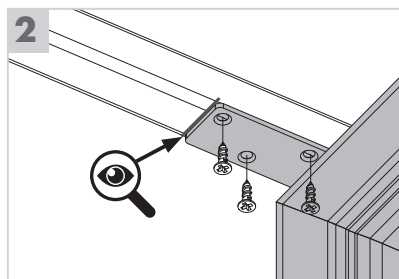
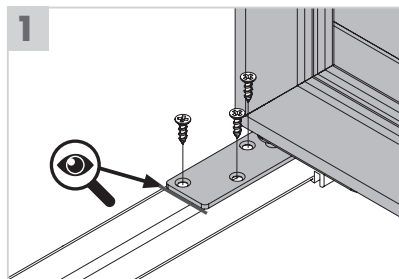
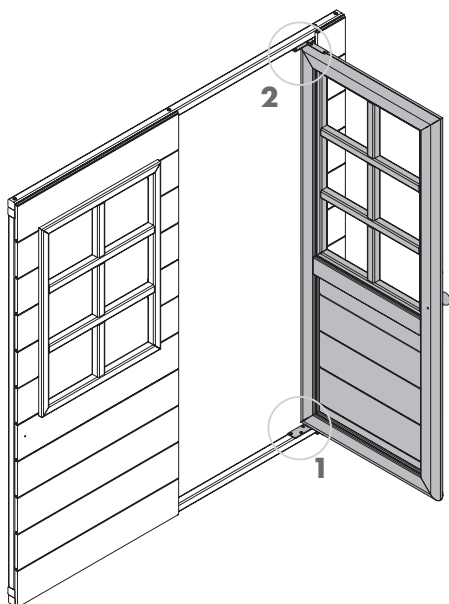
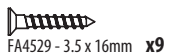
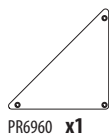

6

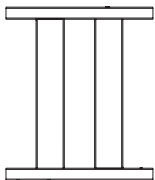

WP3019-WHT x2



FA4523 - 3.5 x 50mm x4

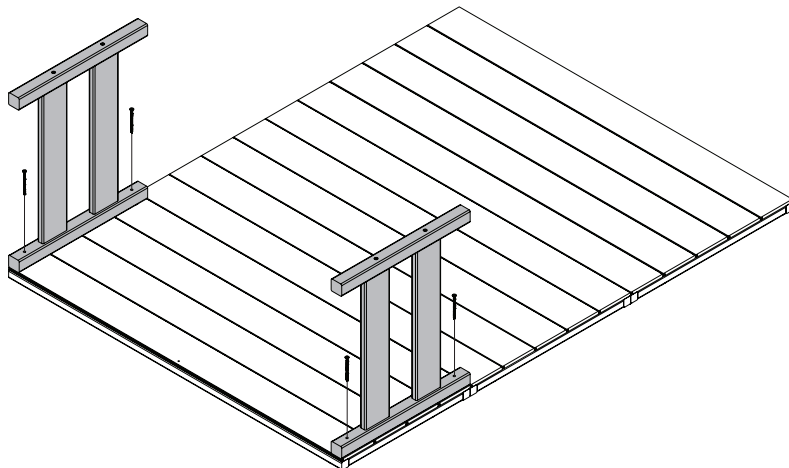

7

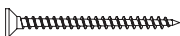

FA4541 - 3.5 x 60mm x5

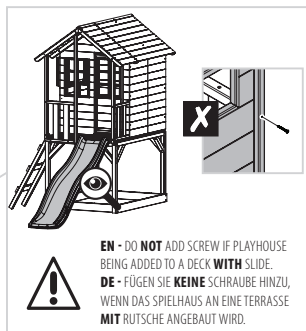
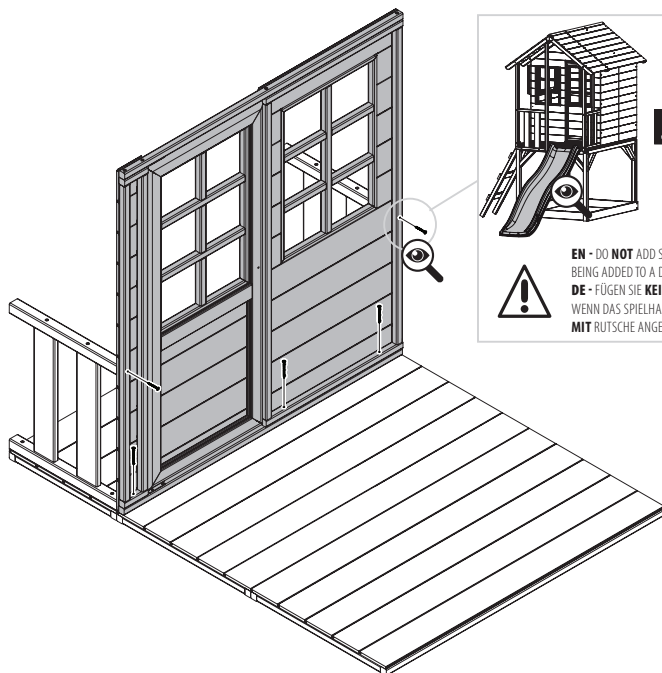

EN - DO NOT ADD SCREW IF PLAYHOUSE BEING ADDED TO A DECK WITH SLIDE.
DE - FÜGEN SIE KEINE SCHRAUBE HINZU, WENN DAS SPIELHAUS AN EINE TERRASSE MIT RUTSCHE ANGEBAUT WIRD.

8

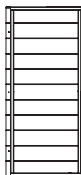

WP3005 **x1**

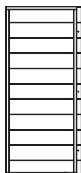

WP3006 **x1**



FA4525 - 3.5 x 35mm **x3**

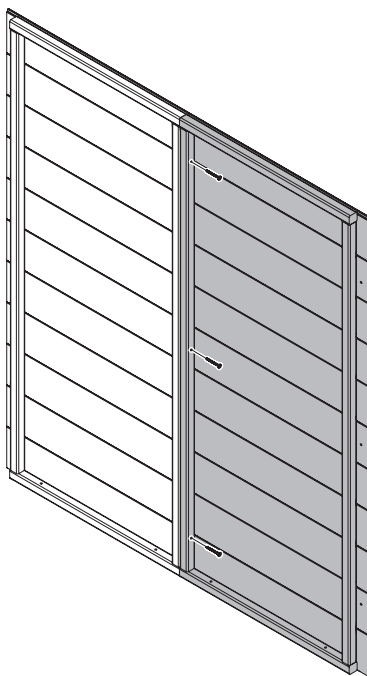

9



FA4535 - 3.5 x 20mm **x3**



FA4522 - 3.5 x 40mm **x4**

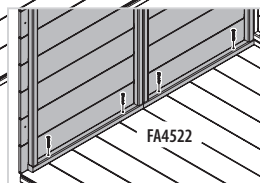
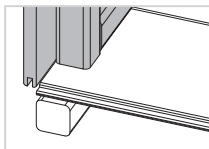
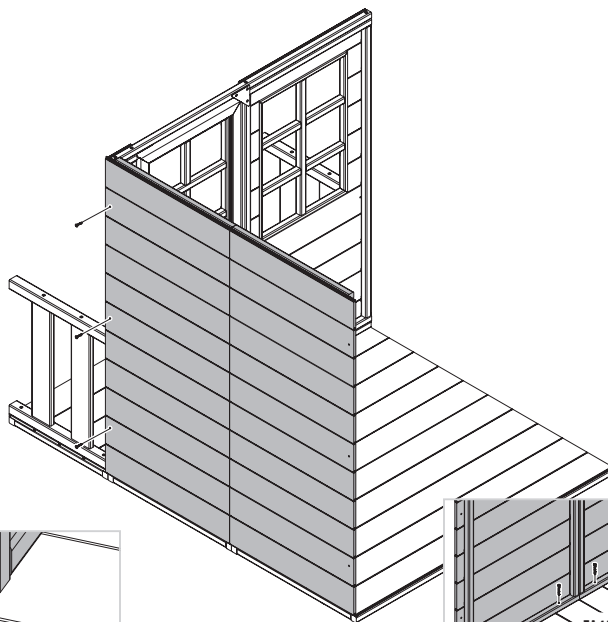

10



FA4513 - 3.5 x 30mm **x4**



FA4525 - 3.5 x 35mm **x2**



FA4522 - 3.5 x 40mm **x4**



MW9309-WHT **x1**

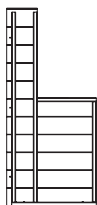

WP3007 **x1**

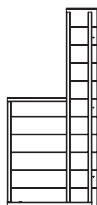

WP3008 **x1**

MW9312 **x1**

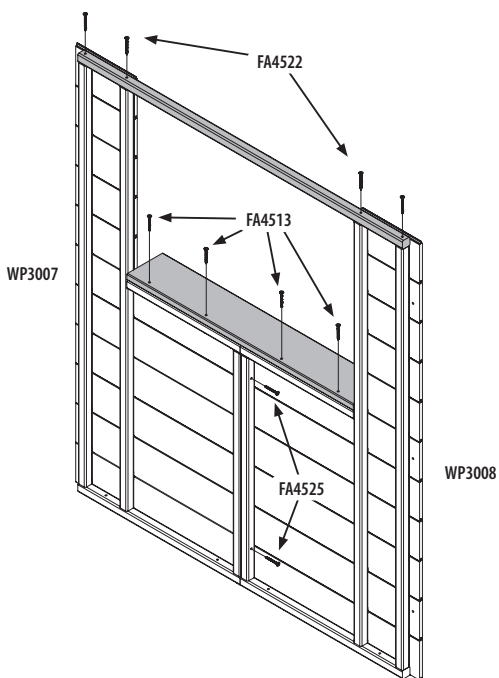

11



FA4535 - 3.5 x 20mm **x3**



FA4522 - 3.5 x 40mm **x4**

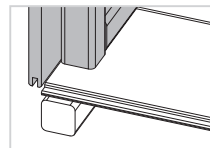
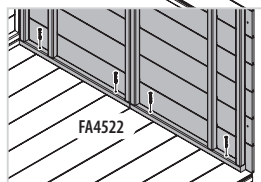
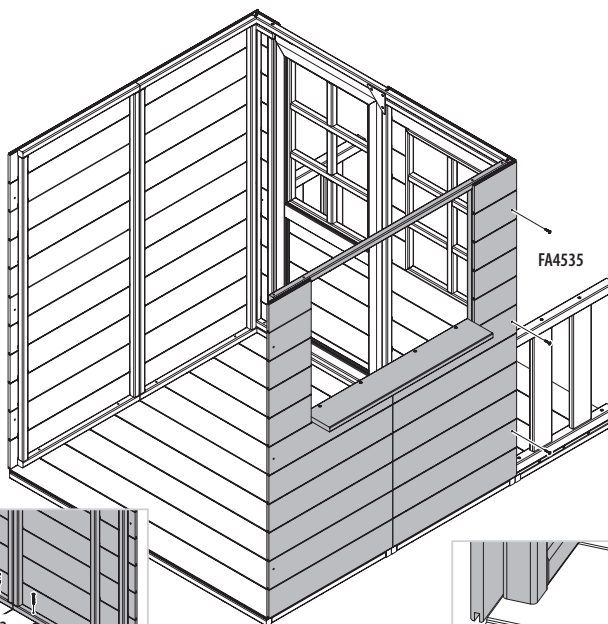

12

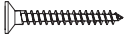

FA4525 - 3.5 x 35mm **x3**

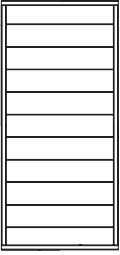

WP3003 **x1**

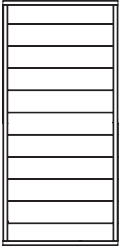

WP3004 **x1**

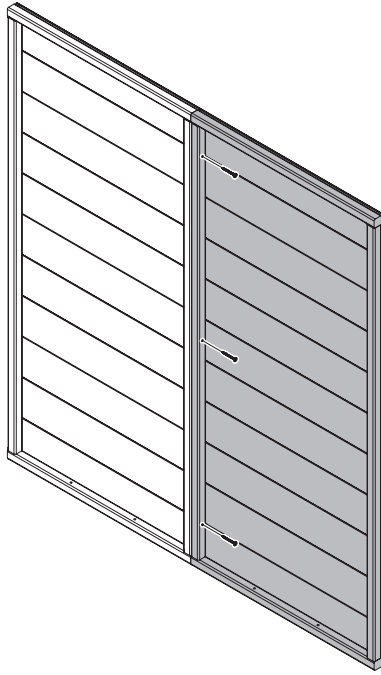

13

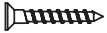

FA4535 - 3.5 x 20mm **x6**

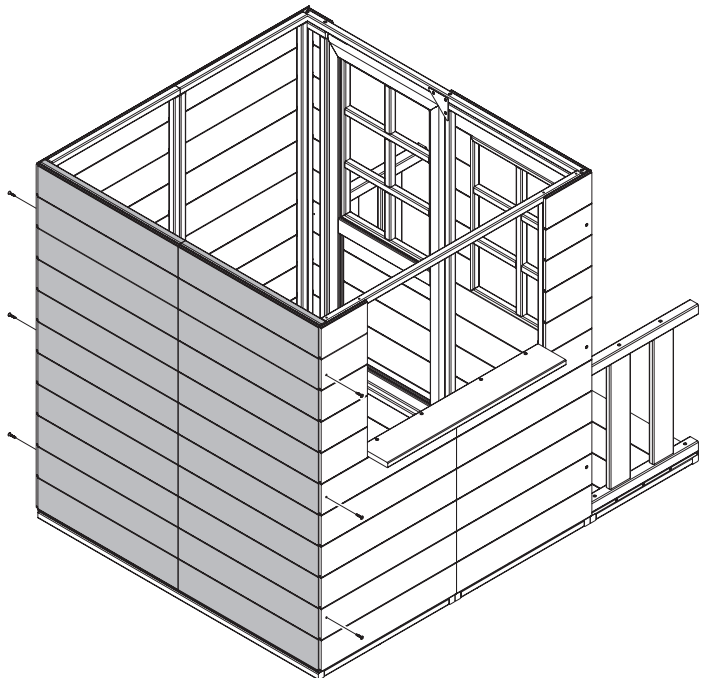

14



FA4522 - 3.5 x 40mm x4

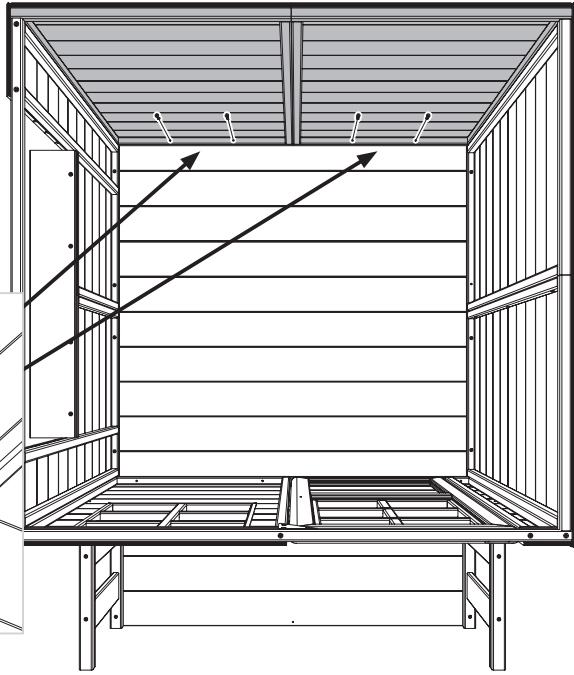
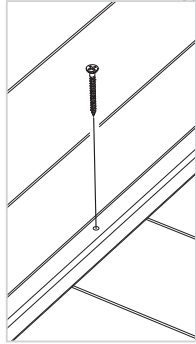

15

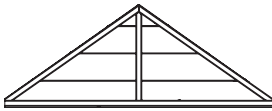

WP3011 x1



FA4525 - 3.5 x 35mm x2

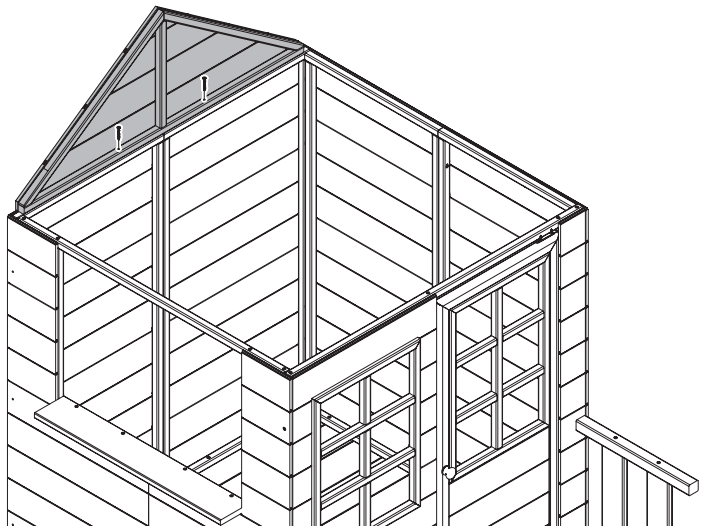
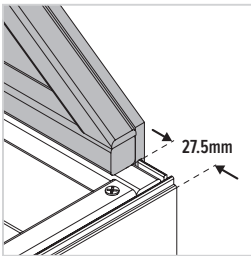

16



WP3011 x1



FA4525 - 3.5 x 35mm x2

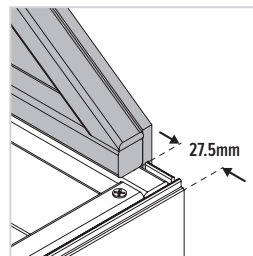
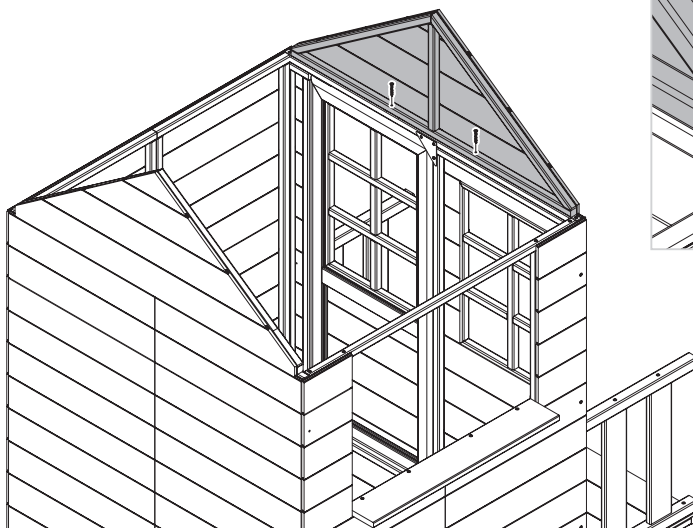

27.5mm

17



MW9314-7016 x12

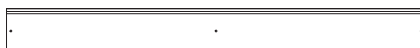

MW9316-7016 x4



MW9289-7016 x4



FA4535 - 3.5 x 20mm x32

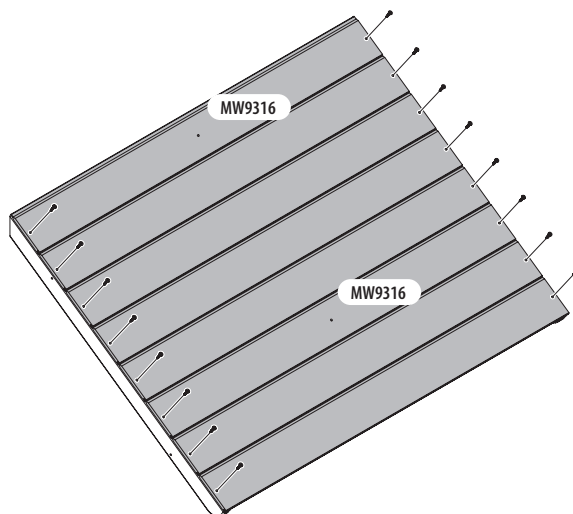

MW9316

MW9316

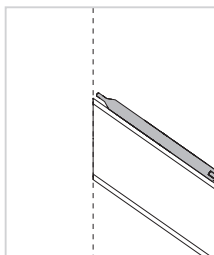

x2

18

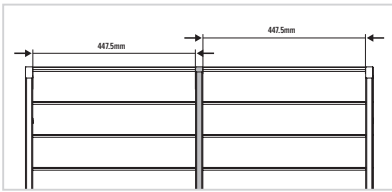
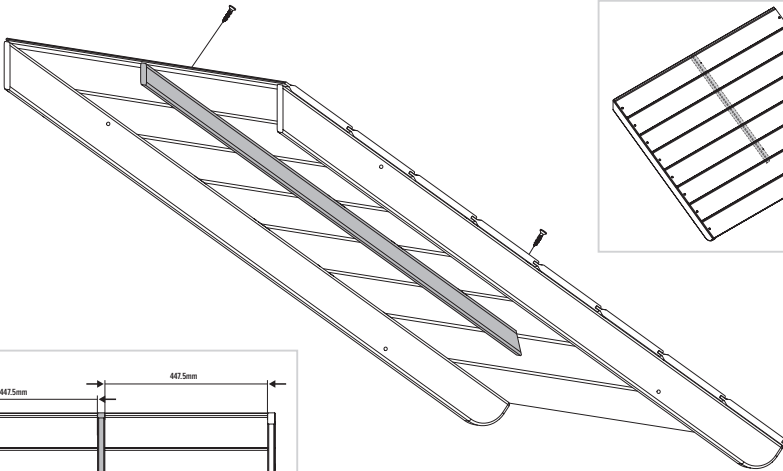
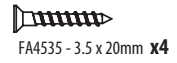

x2

19

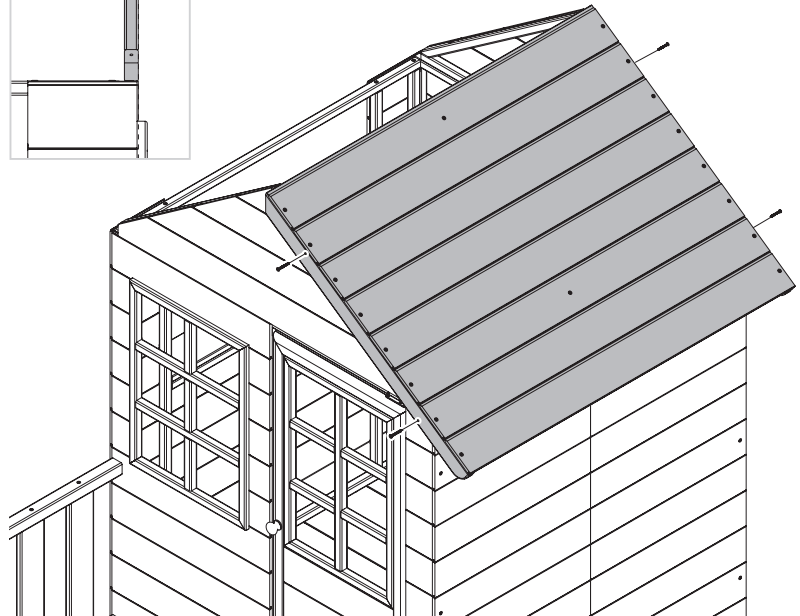
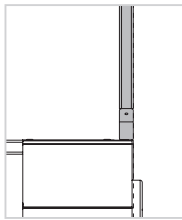
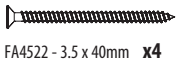

20



FA4522 - 3.5 x 40mm **x4**

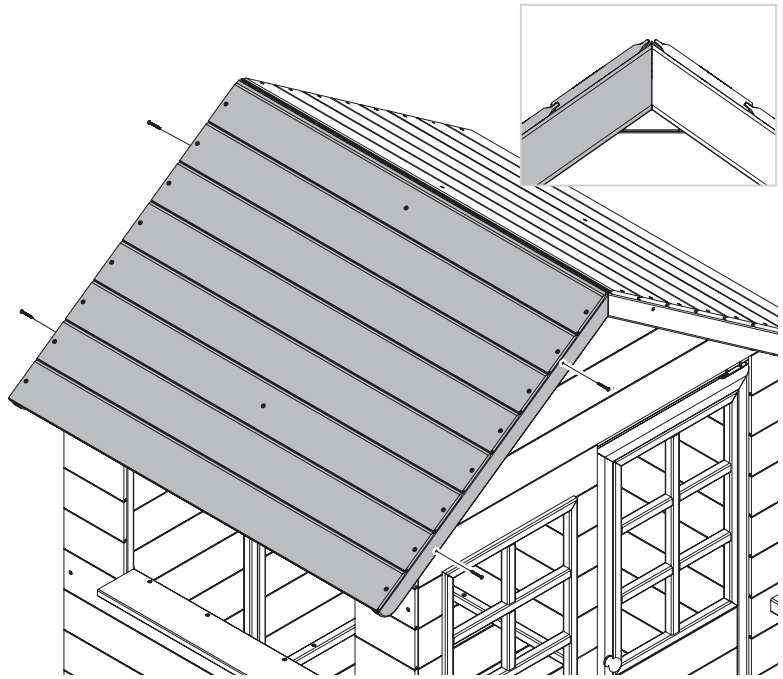

21



MW9319-7016 **x16**



MW9275-7016 **x4**



FA4535 - 3.5 x 20mm **x32**

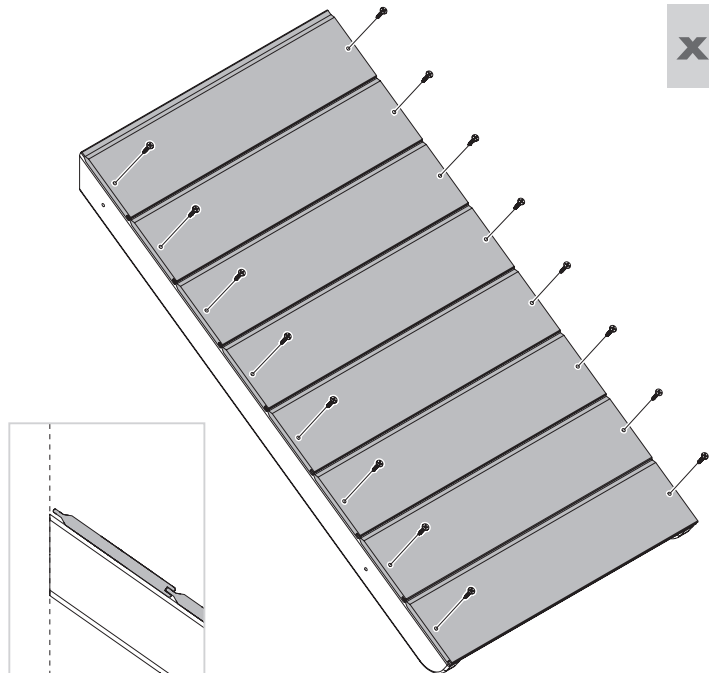

x2

22



FA4522 - 3.5 x 40mm **x4**

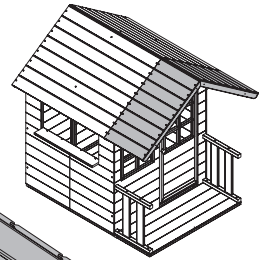
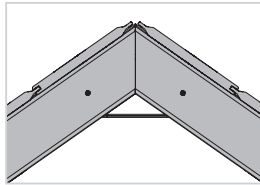

23



MW2113-7016 **x1**



FA4525 - 3.5 x 35mm **x2**

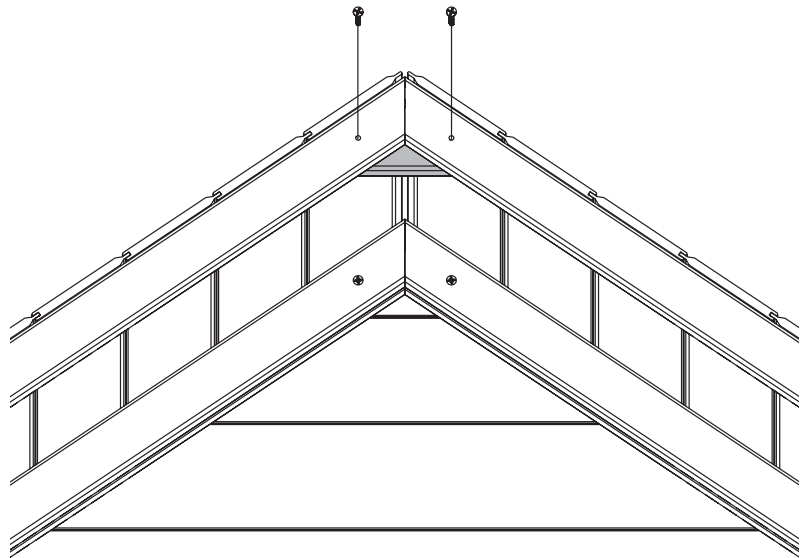

24

- MW9340-WHT x1
- MW2217-WHT x1

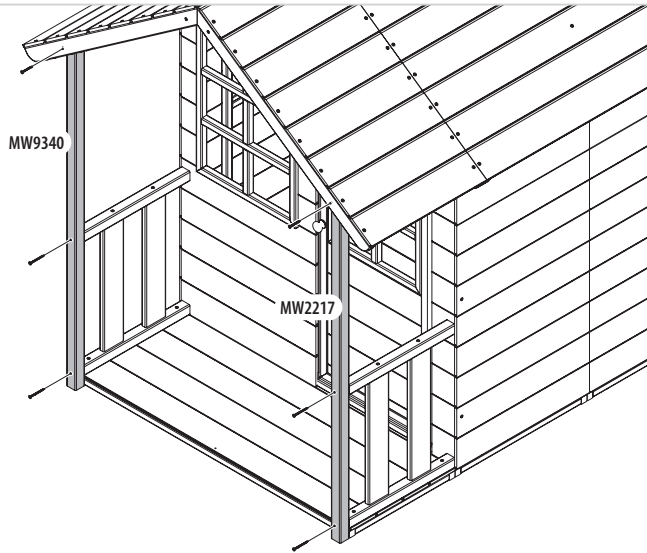

25



MW2116-WHT x2



FA4526 - 3.5 x 30mm x6

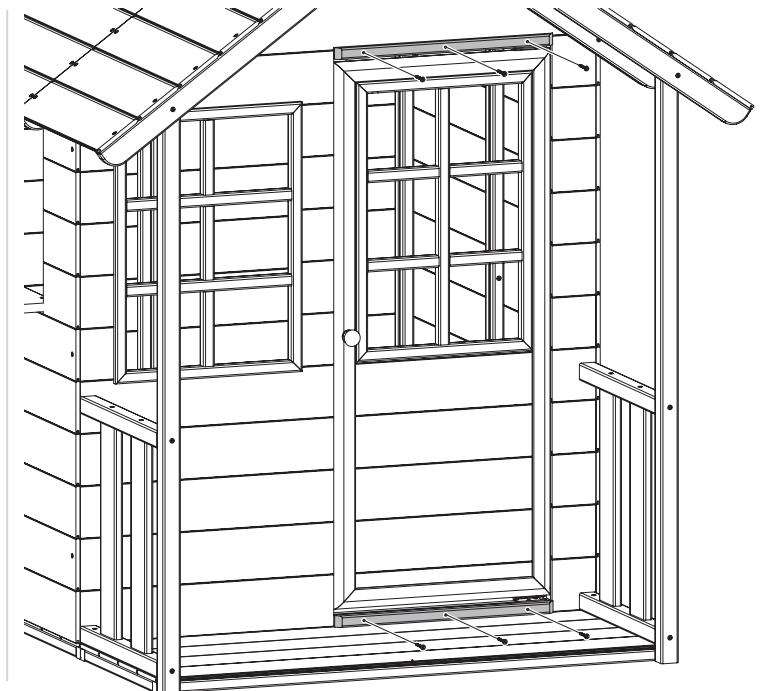

26

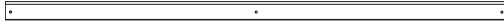

MW9290-WHT x2

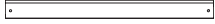

MW9291-WHT x2



PM1970 x1



FA4529 - 3.5 x 16mm x10

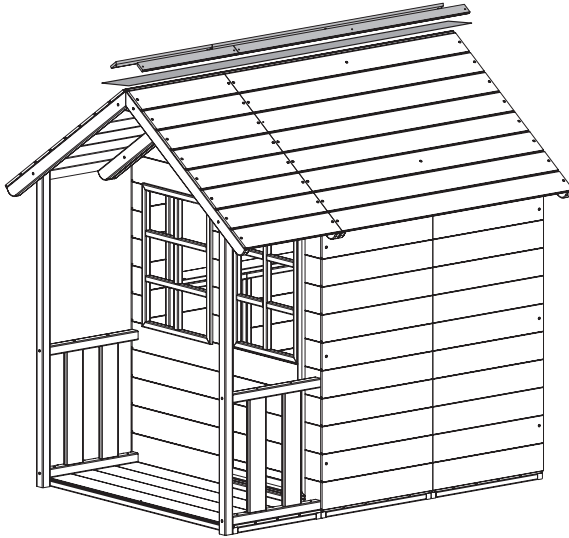

1

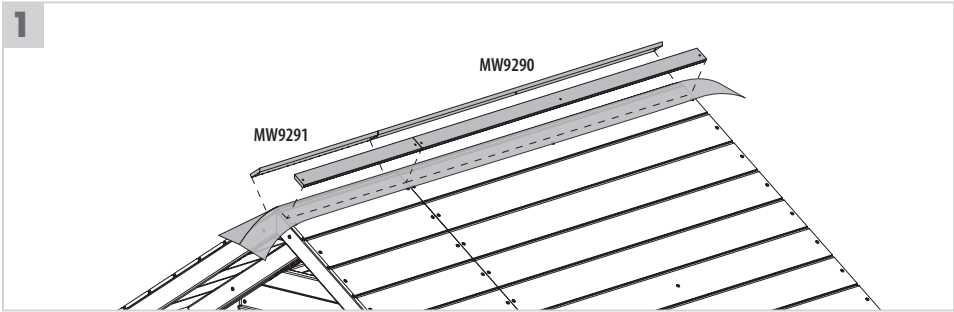

2

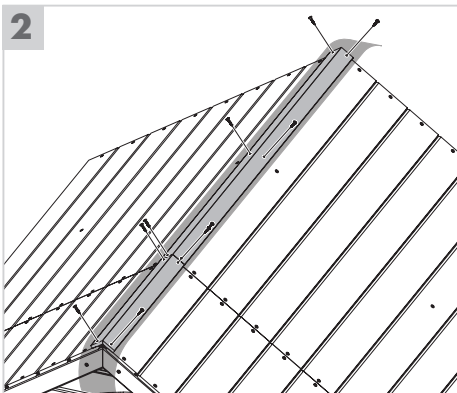

3



27

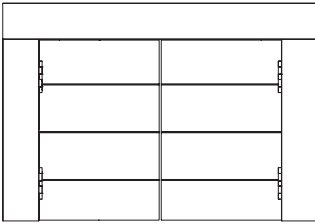

WP2052SA-7016 **x1**

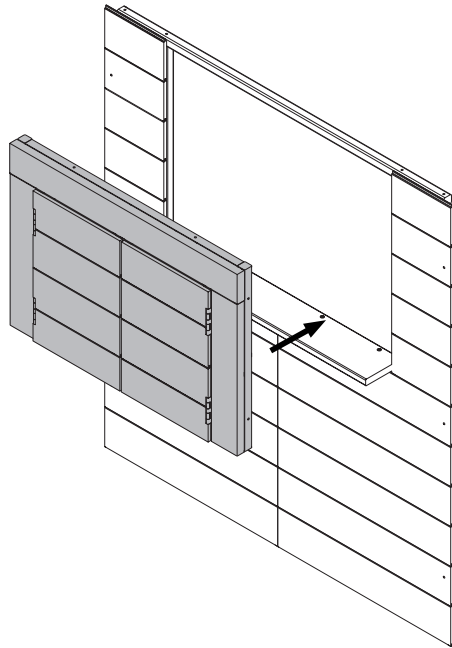

28



FA4522 - 3.5 x 40mm **x2**

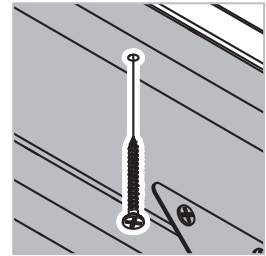
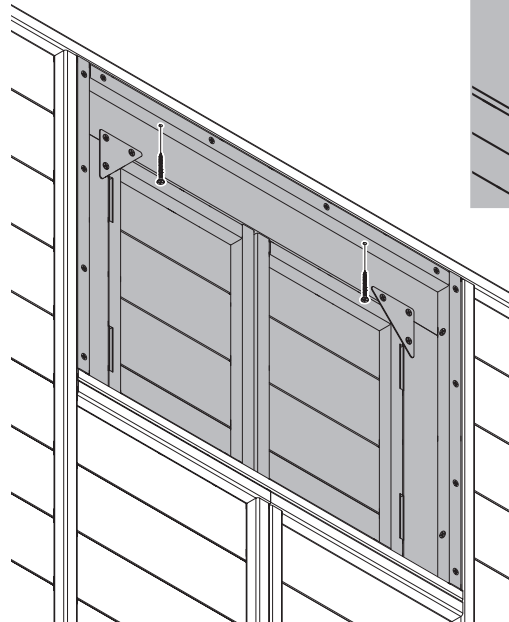

29



FA4522 - 3.5 x 40mm **x4**

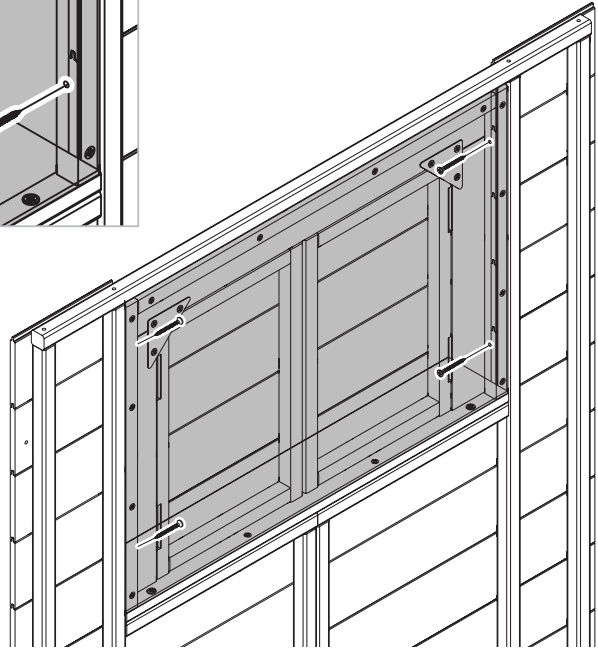
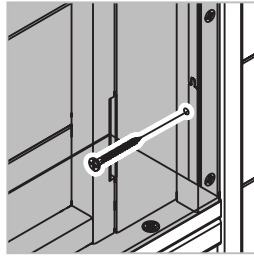

30



MW9346-7016 **x2**



MW3395-7016 **x2**



FA4526 - 3.5 x 30mm **x8**

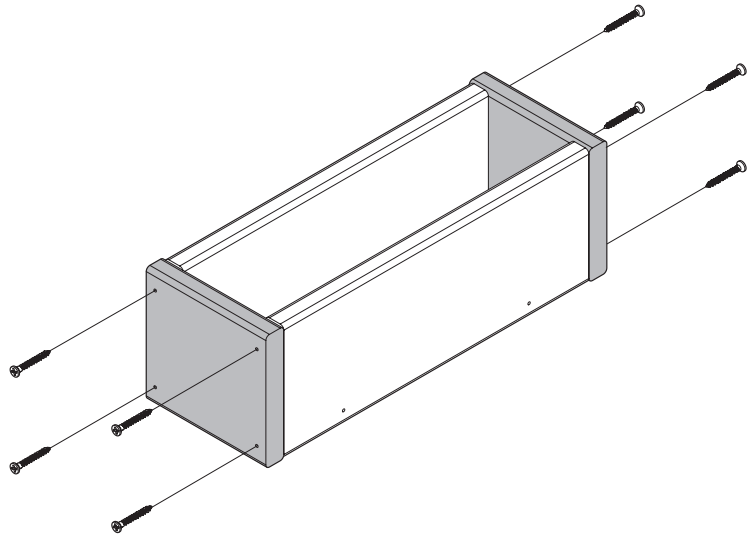

31

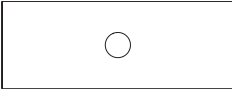

MW9348-7016 **x1**



FA4526 - 3.5 x 30mm **x4**

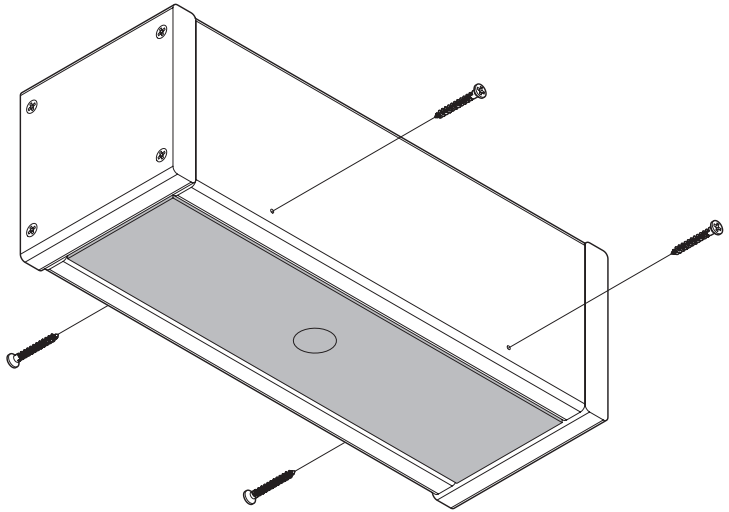

32

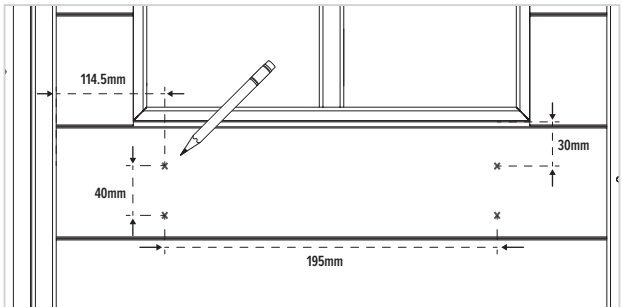
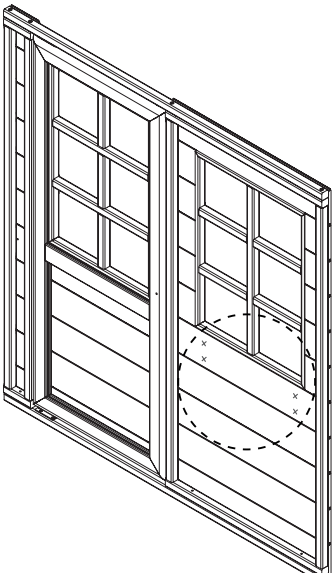

33

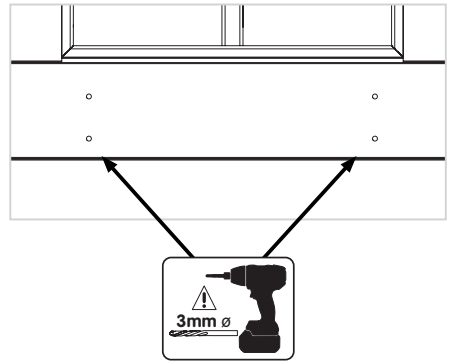
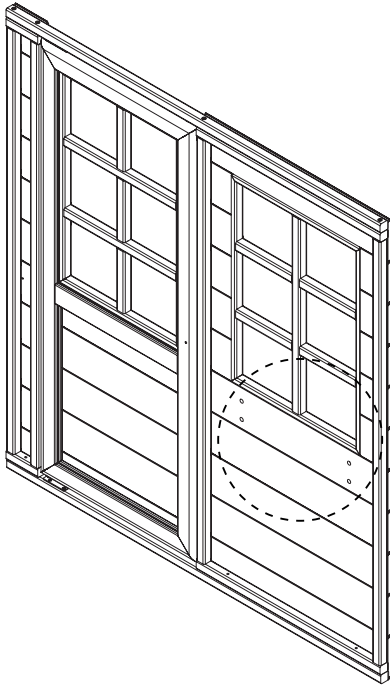

34



FA4542 - 3.5 x 20mm x4

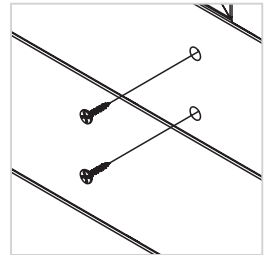
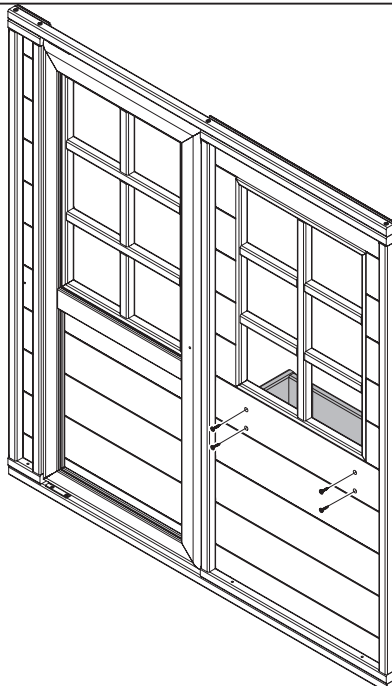

ZWERKULES

EN

Thank you!

Thank you for purchasing this product.

DE

Danke schön!

Vielen Dank für den Kauf dieses Produkts.

50NRTH GmbH

Straßburgstrasse 14-16, D-54516 Wittlich, Germany.

www.50NRTH.com

service@50NRTH.com

+49 (0) 6571 95 117-0

We reserve the right to alter the specification on this product without prior notice.

Wir behalten uns das Recht vor, die Spezifikation dieses Produkts ohne vorherige Ankündigung zu ändern.



RACCOLTA DIFFERENZIATA. VERIFICA LE DISPOSIZIONI DEL TUO COMUNE.



Fait référence au produit Adresses sur quefairedemesdechets.fr



Made in Latvia

ZW373_IN0417ZW-A.02.25